

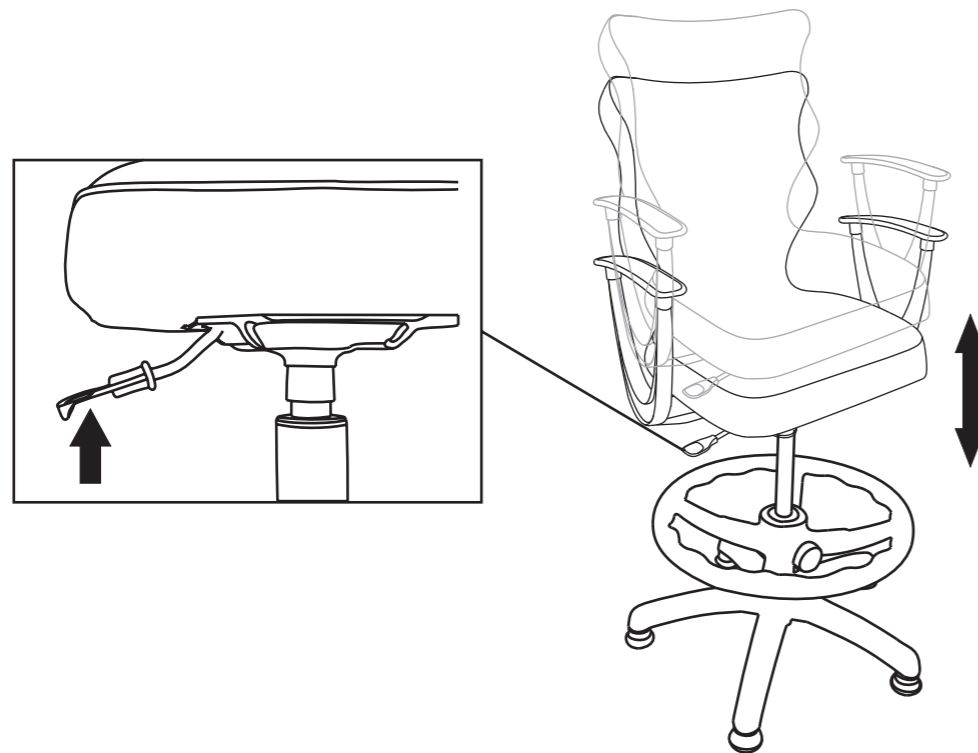

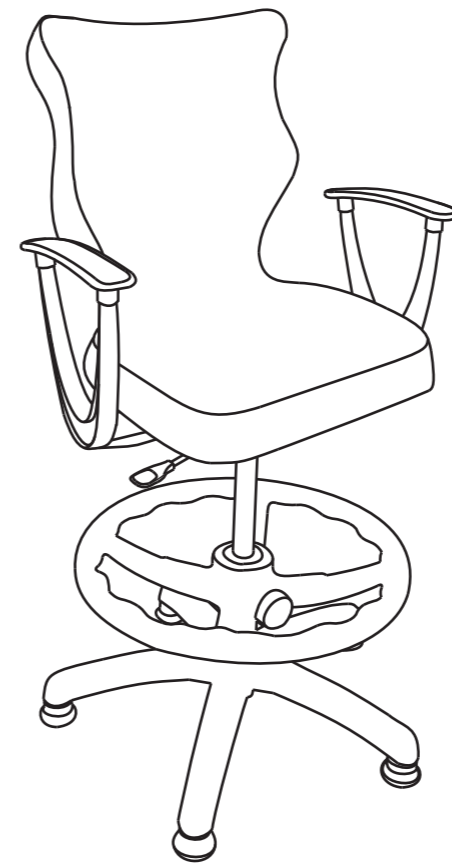

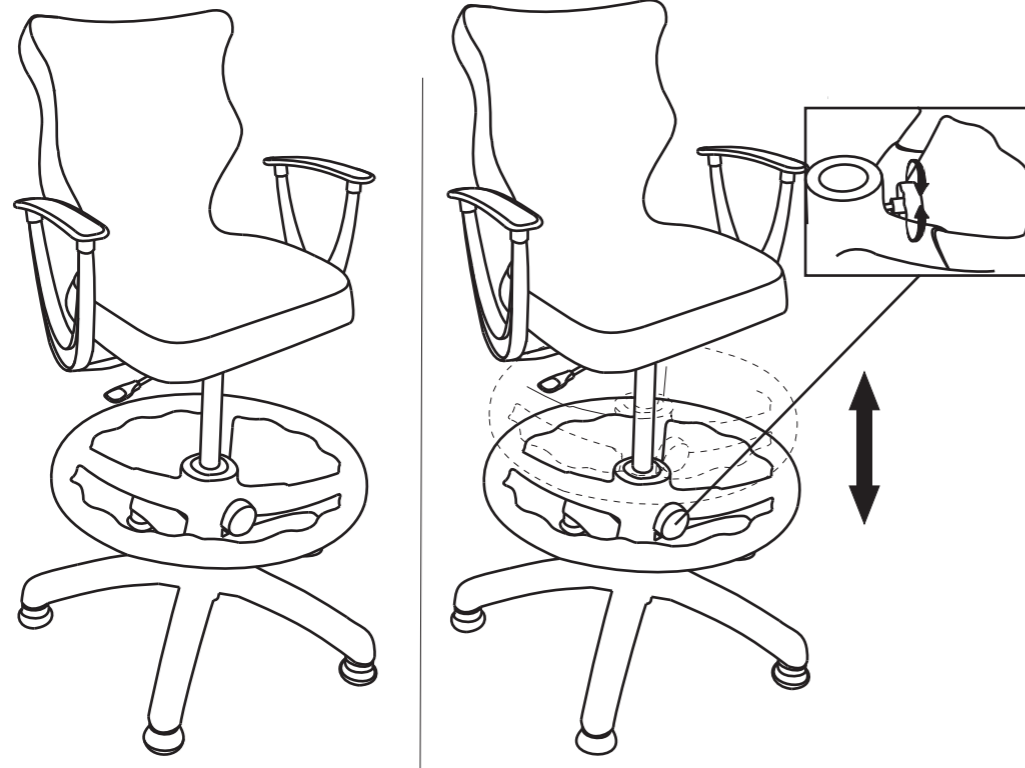

TWIST WK+P

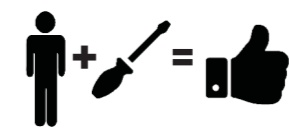

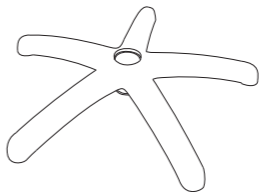
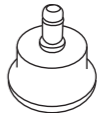
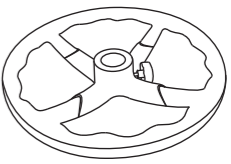
A  1x	B  1x	C  1x	D  5x	E  1x	
F  4x M6X14	G  4x M6X30	H  2x M6X40	I  2x	J  1x	K  2x

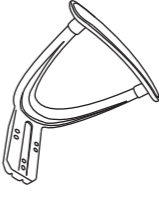
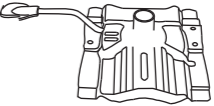
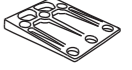

 10min.

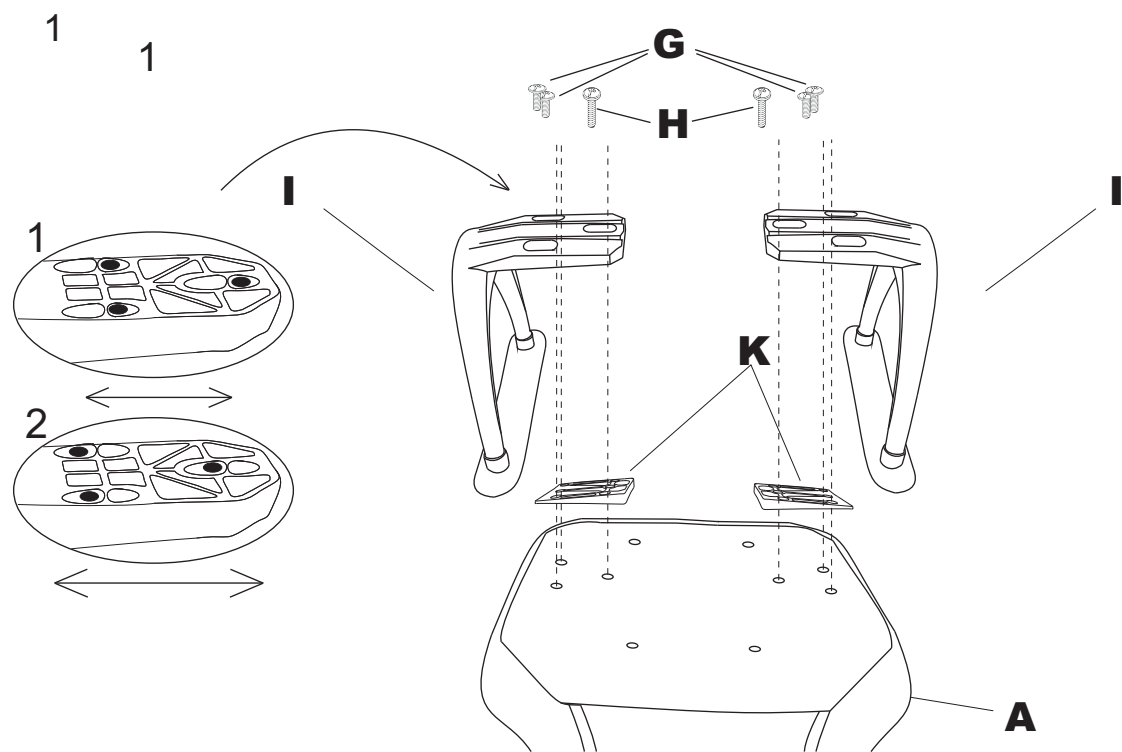

2

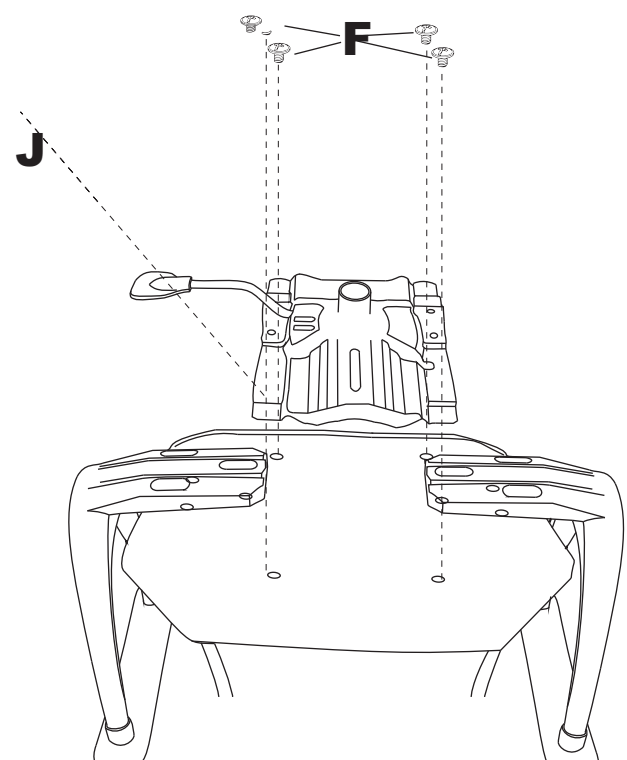

3

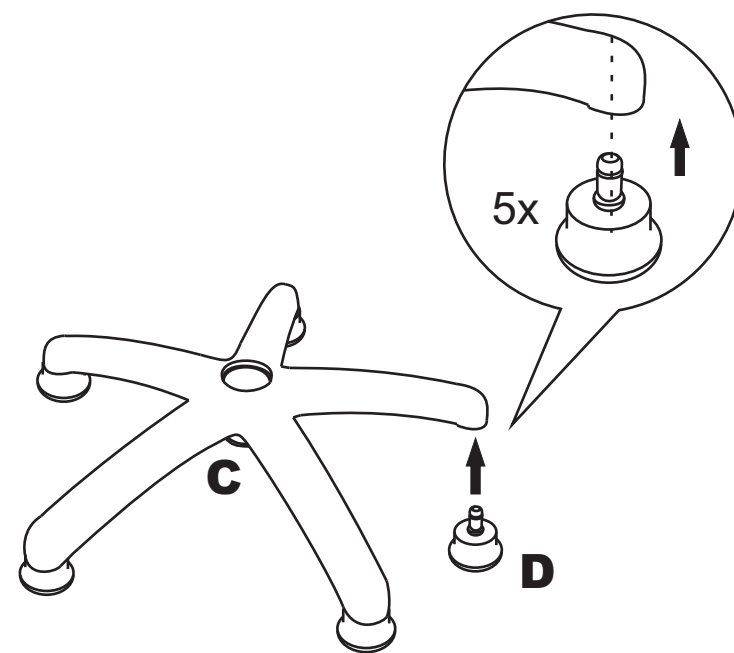

4

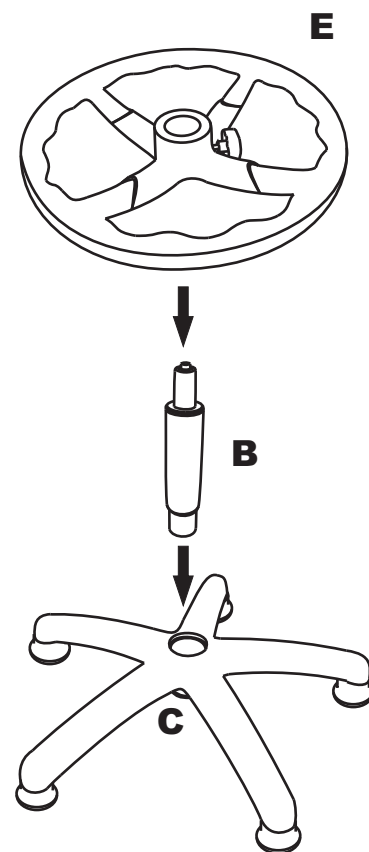

5

